

**HIKVISION**



# **Video Intercom Master Station**

User Manual

UD02932B

## User Manual

©2016 Hangzhou Hikvision Digital Technology Co., Ltd.

This user manual is intended for users of DS-KM8301 Video Intercom Master Station. It includes instructions on how to use the Product. The software embodied in the Product is governed by the user license agreement covering that Product.

### **About this Manual**

This Manual is subject to domestic and international copyright protection. Hangzhou Hikvision Digital Technology Co., Ltd. (“Hikvision”) reserves all rights to this manual. This manual cannot be reproduced, changed, translated, or distributed, partially or wholly, by any means, without the prior written permission of Hikvision.

### **Trademarks**

**HIKVISION** and other Hikvision marks are the property of Hikvision and are registered trademarks or the subject of applications for the same by Hikvision and/or its affiliates. Other trademarks mentioned in this manual are the properties of their respective owners. No right of license is given to use such trademarks without express permission.

### **Disclaimer**

TO THE MAXIMUM EXTENT PERMITTED BY APPLICABLE LAW, HIKVISION MAKES NO WARRANTIES, EXPRESS OR IMPLIED, INCLUDING WITHOUT LIMITATION THE IMPLIED WARRANTIES OF MERCHANTABILITY AND FITNESS FOR A PARTICULAR PURPOSE, REGARDING THIS MANUAL. HIKVISION DOES NOT WARRANT, GUARANTEE, OR MAKE ANY REPRESENTATIONS REGARDING THE USE OF THE MANUAL, OR THE CORRECTNESS, ACCURACY, OR RELIABILITY OF INFORMATION CONTAINED HEREIN. YOUR USE OF THIS MANUAL AND ANY RELIANCE ON THIS MANUAL SHALL BE WHOLLY AT YOUR OWN RISK AND RESPONSIBILITY.

TO THE MAXIMUM EXTENT PERMITTED BY APPLICABLE LAW, IN NO EVENT WILL HIKVISION, ITS DIRECTORS, OFFICERS, EMPLOYEES, OR AGENTS BE LIABLE TO YOU FOR ANY SPECIAL, CONSEQUENTIAL, INCIDENTAL, OR INDIRECT DAMAGES, INCLUDING, AMONG OTHERS, DAMAGES FOR LOSS OF BUSINESS PROFITS, BUSINESS INTERRUPTION, SECURITY BREACHES, OR LOSS OF DATA OR DOCUMENTATION, IN CONNECTION WITH THE USE OF OR RELIANCE ON THIS MANUAL, EVEN IF HIKVISION HAS BEEN ADVISED OF THE POSSIBILITY OF SUCH DAMAGES.

SOME JURISDICTIONS DO NOT ALLOW THE EXCLUSION OR LIMITATION OF LIABILITY OR CERTAIN DAMAGES, SO SOME OR ALL OF THE ABOVE EXCLUSIONS OR LIMITATIONS MAY NOT APPLY TO YOU.

**Support**

Should you have any questions, please do not hesitate to contact your local dealer.

0104001060822

## Regulatory Information

### FCC Information

Please take attention that changes or modification not expressly approved by the party responsible for compliance could void the user's authority to operate the equipment.

**FCC compliance:** This equipment has been tested and found to comply with the limits for a Class A digital device, pursuant to part 15 of the FCC Rules. These limits are designed to provide reasonable protection against harmful interference when the equipment is operated in a commercial environment. This equipment generates, uses, and can radiate radio frequency energy and, if not installed and used in accordance with the instruction manual, may cause harmful interference to radio communications. Operation of this equipment in a residential area is likely to cause harmful interference in which case the user will be required to correct the interference at his own expense.

### FCC Conditions

This device complies with part 15 of the FCC Rules. Operation is subject to the following two conditions:

1. This device may not cause harmful interference.
2. This device must accept any interference received, including interference that may cause undesired operation.

### EU Conformity Statement



This product and - if applicable - the supplied accessories too are marked with "CE" and comply therefore with the applicable harmonized European standards listed under the EMC Directive 2004/108/EC, the RoHS Directive 2011/65/EU.



2012/19/EU (WEEE directive): Products marked with this symbol cannot be disposed of as unsorted municipal waste in the European Union. For proper recycling, return this product to your local supplier upon the purchase of equivalent new equipment, or dispose of it at designated collection points. For more information see: [www.recyclethis.info](http://www.recyclethis.info)



2006/66/EC (battery directive): This product contains a battery that cannot be disposed of as unsorted municipal waste in the European Union. See the product documentation for specific battery information. The battery is marked with this symbol, which may include lettering to indicate cadmium (Cd), lead (Pb), or mercury (Hg). For proper recycling, return the battery to your supplier or to a designated collection point. For more information see: [www.recyclethis.info](http://www.recyclethis.info)

### Industry Canada ICES-003 Compliance

This device meets the CAN ICES-3 (A)/NMB-3(A) standards requirements.



## Safety Instruction

These instructions are intended to ensure that user can use the product correctly to avoid danger or property loss.

The precaution measure is divided into **Warnings** and **Cautions**:

**Warnings:** Neglecting any of the warnings may cause serious injury or death.

**Cautions:** Neglecting any of the cautions may cause injury or equipment damage.

	
<b>Warnings</b> Follow these safeguards to prevent serious injury or death.	<b>Cautions</b> Follow these precautions to prevent potential injury or material damage.



### Warnings

All the electronic operation should be strictly compliance with the electrical safety regulations, fire prevention regulations and other related regulations in your local region.

Please use the power adapter, which is provided by normal company. The power consumption cannot be less than the required value.

Do not connect several devices to one power adapter as adapter overload may cause over-heat or fire hazard.

Please make sure that the power has been disconnected before you wire, install or dismantle the device.

When the product is installed on wall or ceiling, the device shall be firmly fixed.

If smoke, odors or noise rise from the device, turn off the power at once and unplug the power cable, and then please contact the service center.

If the product does not work properly, please contact your dealer or the nearest service center. Never attempt to disassemble the device yourself. (We shall not assume any responsibility for problems caused by unauthorized repair or maintenance.)



### Cautions

Do not drop the device or subject it to physical shock, and do not expose it to high electromagnetic radiation. Avoid the equipment installation on vibrations surface or places subject to shock (ignorance can cause equipment damage).

Do not place the device in extremely hot (refer to the specification of the device for the detailed operating temperature), cold, dusty or damp locations, and do not expose it to high electromagnetic radiation.

The device cover for indoor use shall be kept from rain and moisture.

Exposing the equipment to direct sun light, low ventilation or heat source such as heater or radiator is forbidden (ignorance can cause fire danger).

Do not aim the device at the sun or extra bright places. A blooming or smear may occur otherwise (which is not a malfunction however), and affecting the endurance of sensor at the same time.

Please use the provided glove when open up the device cover, avoid direct contact with the device cover, because the acidic sweat of the fingers may erode the surface coating of the device cover.

Please use a soft and dry cloth when clean inside and outside surfaces of the device cover, do not use alkaline detergents.

Please keep all wrappers after unpack them for future use. In case of any failure occurred, you need to return the device to the factory with the original wrapper. Transportation without the original wrapper may result in damage on the device and lead to additional costs.

Improper use or replacement of the battery may result in hazard of explosion. Replace with the same or equivalent type only. Dispose of used batteries according to the instructions provided by the battery manufacturer.

# Contents

<b>1 Overview</b> .....	<b>2</b>
1.1 Appearance of DS-KM8301 Model .....	2
1.2 Typical Application.....	4
1.3 Terminals and Interfaces.....	4
<b>2 Before You Start</b> .....	<b>6</b>
<b>3 Local Operation</b> .....	<b>7</b>
3.1 Activating Device .....	7
3.2 User Interface Description .....	7
3.3 Status .....	8
3.4 Configuration Settings .....	9
3.4.1 Changing Configuration Password.....	9
3.4.2 Setting Local Information .....	9
3.4.3 Setting Network .....	10
3.4.4 SIP (Session Initiation Protocol) Server Management .....	11
3.4.5 Adding Devices.....	12
3.4.6 Synchronizing Time .....	15
3.4.7 Restoring Default Settings .....	16
3.5 Video Call Settings .....	17
3.5.1 Calling Resident.....	17
3.5.2 Calling Master Station .....	17
3.5.3 Adding Resident Information .....	18
3.5.4 Viewing Call Logs.....	18
3.6 Viewing Alarm Messages .....	19
3.7 Live View.....	20
<b>4 Remote Configuration via Batch Configuration Tool</b> .....	<b>23</b>
4.1 Activating Device Remotely .....	23
4.2 Editing Network Parameters .....	24
4.3 Adding Device .....	25
4.3.1 Adding Online Device .....	25
4.3.2 Adding by IP Address.....	26
4.3.3 Adding by IP Segment .....	27
4.4 Configuring Devices Remotely .....	28
4.4.1 System.....	28
4.4.2 Video Intercom.....	33
4.4.3 Network .....	36
4.5 Batch Upgrading .....	37
4.5.1 Adding Devices for Upgrading.....	38
4.5.2 Upgrading Devices.....	40
<b>5 Remote Operation via iVMS-4200</b> .....	<b>42</b>

5.1 System Configuration.....	42
5.2 Device Management.....	43
5.2.1 Adding Video Intercom Devices .....	43
5.2.2 Modifying Network Information .....	45
5.2.3 Resetting Password .....	46
5.3 Configuring Devices Remotely via iVMS-4200 .....	48
5.4 Device Arming Control.....	48
<b>Appendix .....</b>	<b>50</b>
Wiring Cables.....	50



# 1 Overview

The DS-KM8301 master station is an intelligent terminal for video intercom system management. It responds and sends the residents call, receives alarm, and unlocks door remotely. It is normally installed on the management center, it can be operated with a capacitive touch screen, touch buttons and mechanical buttons.

## Features:

- Glass panel and aluminum-alloy bracket
- Supports video intercom
- Supports live view of door stations and IP cameras
- Noise suppression and echo cancellation
- Supports hands-free mode
- Alarm processing function
- Supports remote unlocking door function
- Supports on-table mode
- Supports working as a management center and a SIP server simultaneously

## 1.1 Appearance of DS-KM8301 Model

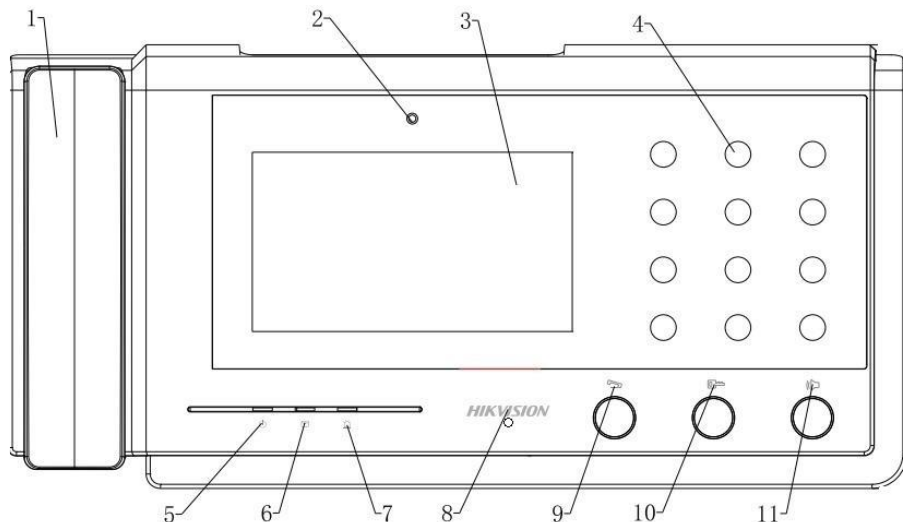

Figure 1-1 Front Panel

Table 1-1 Descriptions

<b>No.</b>	<b>Description</b>
1	Phone
2	Camera
3	Display
4	Dial Keyboard
5	Power Indicator
6	Information Indicator
7	Alarm Indicator
8	Microphone
9	Call/End Call Button
10	Unlock Button
11	Speaker Button

## 1.2 Typical Application

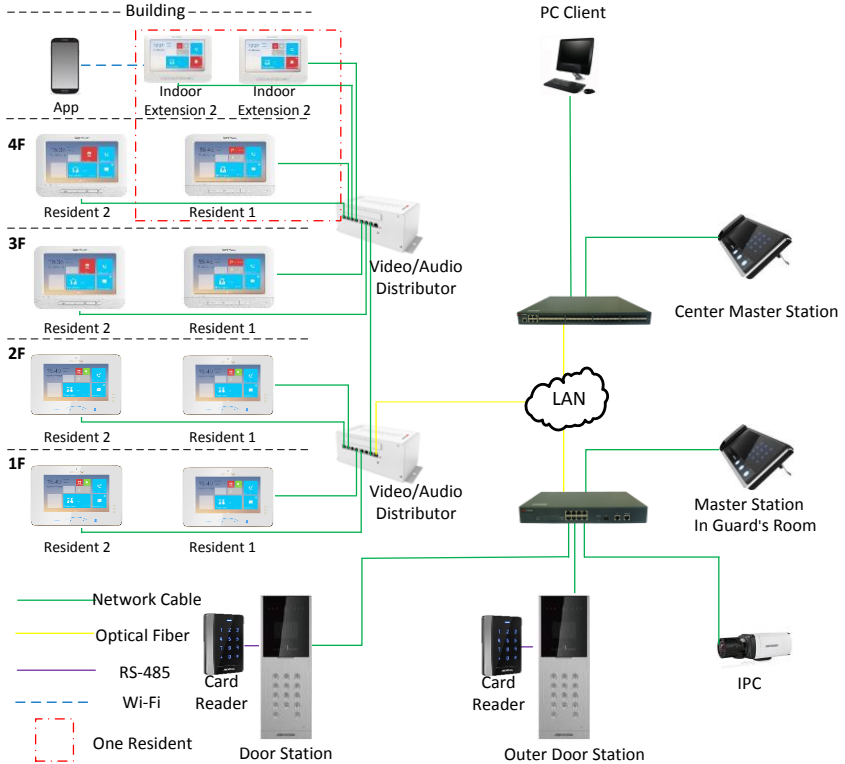

Figure 1-2 Typical Application of Master Station

## 1.3 Terminals and Interfaces

Please refer to the following figure for terminals and interfaces of master station.

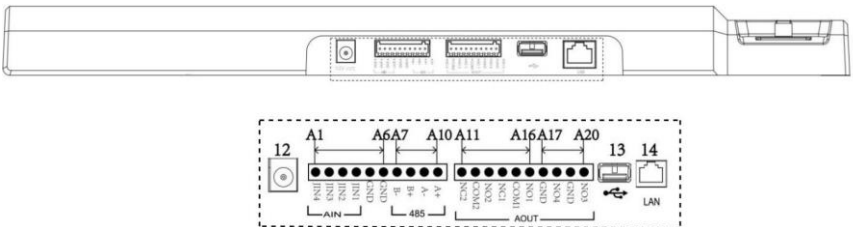

Figure 1-3 Real Panel

Table 1-2 Descriptions of Terminals and Interfaces

<b>Name</b>	<b>No.</b>	<b>Interface</b>	<b>Description</b>
Power Supply	12	Power	2-Chip; DC 12V
USB Interface	13	USB	For U-disk Connection
Network Interface	14	LAN	Network Interface
ALARM IN	A1	JIN4	Alarm Input 4 (reserved)
	A2	JIN3	Alarm Input 3 (reserved)
	A3	JIN2	Alarm Input 2 (reserved)
	A4	JIN1	Alarm Input 1 (reserved)
	A5	GND	Grounding
	A6	GND	Grounding
RS485	A7	B-	RS485 Communication Interfaces
	A8	B+	
	A9	A-	
	A10	A+	
ALARM OUT	A11	NC2	Alarm Input 2 (NC/reserved)
	A12	COM2	
	A13	NO2	Alarm Input 2 (NO/reserved)
	A14	NC1	Alarm Input 1 (NC/reserved)
	A15	COM1	
	A16	NO1	Alarm Input 1 (NO/reserved)
	A17	GND	Grounding
	A18	NO4	Optical Coupler Output 4
	A19	GND	Grounding
	A20	NO3	Optical Coupler Output 3

## 2 Before You Start

---

For the first time use of the device, you are required to activate the device and set the device password. You can activate the device locally or remotely via internet with Batch Configuration Tool, or with iVMS-4200 client software.



To remotely activate the device with Batch Configuration Tool or iVMS-4200, refer to Chapter 4, and Chapter 5.

To configure key parameters of the device on the user interface of master station, you are required to enter the admin (configuration) password.

The default admin password is **888999**.

You must change the default credential to protect against unauthorized access to the product. Please refer to 3.4.1 and 4.4.2 for changing password.

## 3 Local Operation

### 3.1 Activating Device

Connect the power cable to power on the master station.

You must create a password to activate the master station for your first time usage and when it is not activated.

Only after activating the device, you can operate it both locally and remotely.



- The password created for the activation is only used when you add the station to the remote control software such as iVMS-4200.
- To remotely access to the device, use the password here registered to add the device to the remote client.

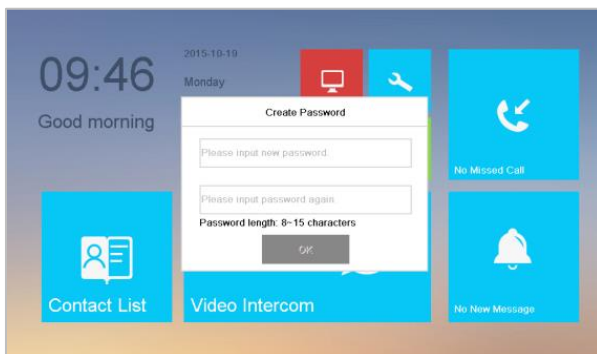

Figure 3-1 Activation Interface

**STRONG PASSWORD RECOMMENDED**— We highly recommend you to create a strong password of your own choosing (using a minimum of 8 characters, including at least three kinds of following categories: upper case letters, lower case letters, numbers, and special characters) in order to increase the security of your product. And we recommend you reset your password regularly, especially in the high security system, resetting the password monthly or weekly can better protect your product.



### 3.2 User Interface Description

Please refer to the following figure for the user interface of master station.

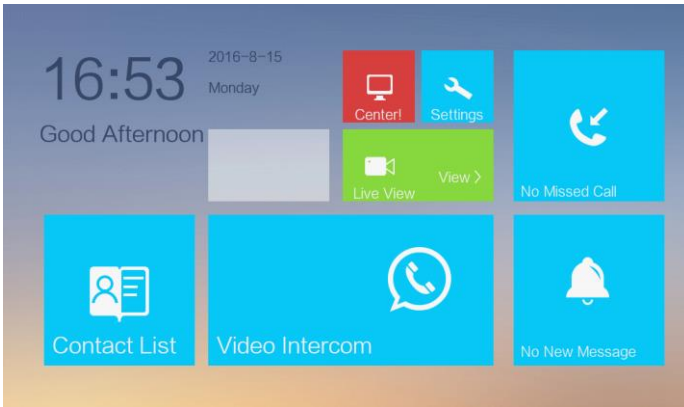





Figure 3-2 User Interface

### 3.3 Status

Icon	Definition	Description
	Normal Status.	The connection between master station and indoor/door stations is normal, and the master station has successfully registered to the SIP server.
	The master station is offline.	Please check the network cable of the master station.
	The master station has not registered to the SIP server.	Invalid SIP server IP address. Set the SIP server IP address.
		Network of SIP server is not available. Check the SIP server network connection.
		SIP server communication is not available. Check if the SIP server IP address is correct.
	Invalid master station IP address	SIP server rejected to login the device. Check if the device No. has been registered.
		The master station IP address conflicts with other devices' IP address.

## 3.4 Configuration Settings

### Purpose:

You can set and view the local information, configure the network, manage devices, synchronize the device time, and restore the default settings.

You can get to the configuration interface: **Settings -> Configuration**.

### 3.4.1 Changing Configuration Password

The configuration password is required when you configure the master station locally, such as viewing the local information, setting the network, adding devices, setting the time, and restoring default settings.

#### Steps:

1. Press the **Settings** tab on the touch screen and press the **Edit** tab to change the password.
2. Enter the old password to change it.
3. Enter a new password and confirm it.



- The configuration password is also called admin password on the device.
- The default configuration password (admin password) is 888999.

**STRONG PASSWORD RECOMMENDED**— *We highly recommend you to create a strong password of your own choosing (using a minimum of 8 characters, including at least three kinds of following categories: upper case letters, lower case letters, numbers, and special characters) in order to increase the security of your product. And we recommend you reset your password regularly, especially in the high security system, resetting the password monthly or weekly can better protect your product.*



### 3.4.2 Setting Local Information

#### Steps:

1. Get to the configuration interface: **Settings -> Configuration**, and enter the admin password (configuration password).
2. Press the **Local Info** tab to enter the local information settings interface.
3. Set the Community No. and No. for the master station, and set the maximum live view duration.



- The No. ranges from 51 to 99.
- The maximum live view duration varies from 10 seconds to 60 seconds.



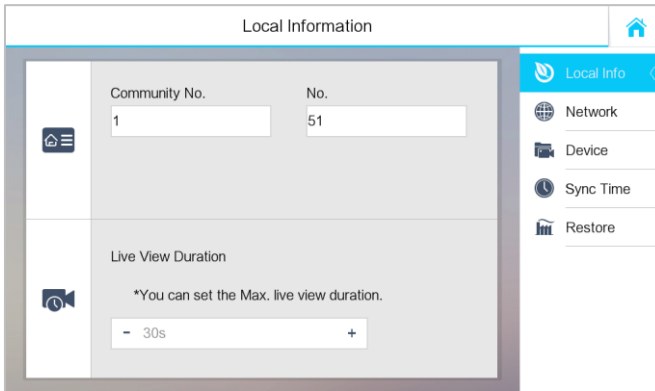

Figure 3-3 Local Information Settings

### 3.4.3 Setting Network



Make sure the network cable is well-connected.

**Purpose:**

The connection of the network is mandatory for the use of the master station.

**Steps:**

1. Get to the configuration interface: **Settings -> Configuration**, and enter the admin password (configuration password).
2. Press the **Network** tab to enter the network settings interface.

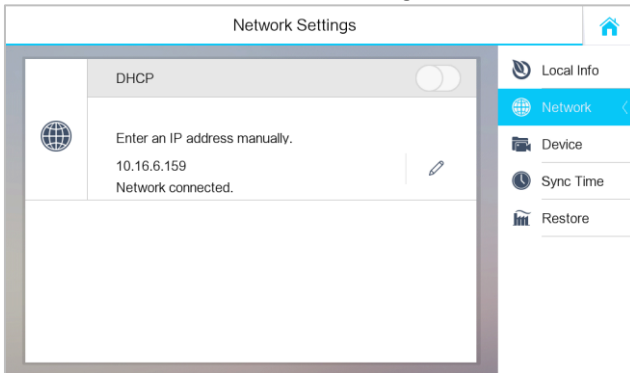



Figure 3-4 Network Settings Interface

3. Press the  tab to pop up network settings dialogue box.

Network Settings	
Local IP	10.16.6.159
Subnet Mask	255.255.255.0
Gateway	10.16.6.254

Figure 3-5 Setting Network

4. Enter a local IP address, subnet mask, and gateway.
5. Press the **Save** tab.



Enable **DHCP** function to obtain an IP address automatically.

### 3.4.4 SIP (Session Initiation Protocol) Server Management

The master station can work as a management center and SIP server simultaneously.

#### Working as a SIP server

When setting the master station's IP address as the SIP server address on the master station and on the indoor/door station simultaneously, the master station can receive alarm messages from indoor/door stations once there are alarms triggered in the indoor/door stations.

#### Requiring Connecting to a SIP server

The master station can also be connected to an independent SIP server.

##### **Steps:**

1. Get to the configuration interface: **Settings -> Configuration**, and enter the admin password (configuration password).
2. Press the **Device** tab, and press the **SIP Server** tab.

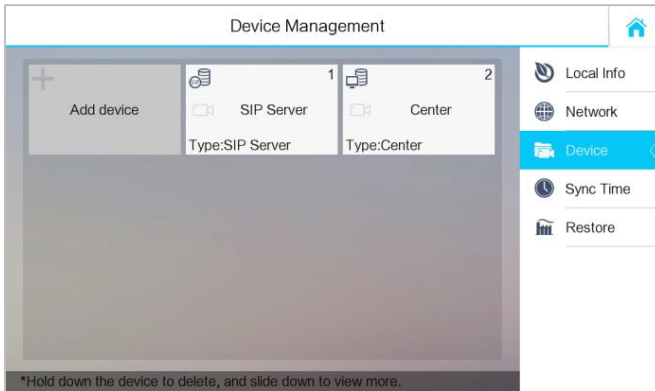

Figure 3-6 SIP Server Adding

3. Enter the IP address of the SIP server.
4. Press the **Save** button to save the SIP server added.

### 3.4.5 Adding Devices

**Purpose:**

The master station never works alone. You can connect the door station, outer door station, IP camera, DVR, DVS, and NVR. Once connected, those devices can work together as a whole video intercom system.



- Hold the device to open the device operation menu for deleting the selected device or clearing all devices (excluding management center and SIP server).
- SIP server and management center can only be edited but not deleted.

**Steps:**

1. Get to the configuration interface: **Settings -> Configuration**, and enter the admin password (configuration password).
2. Press the **Device** tab.

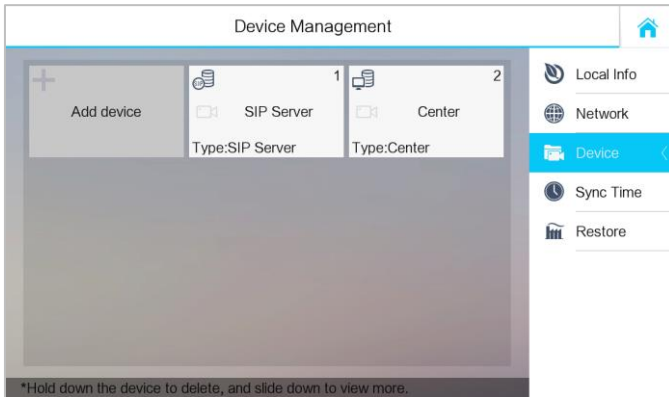

Figure 3-7 Device Management

### Adding the Door Station or Outer Door Station

**Steps:**

1. Press the **Add Device** tab to pop up the **Select Device Type** dialogue box.

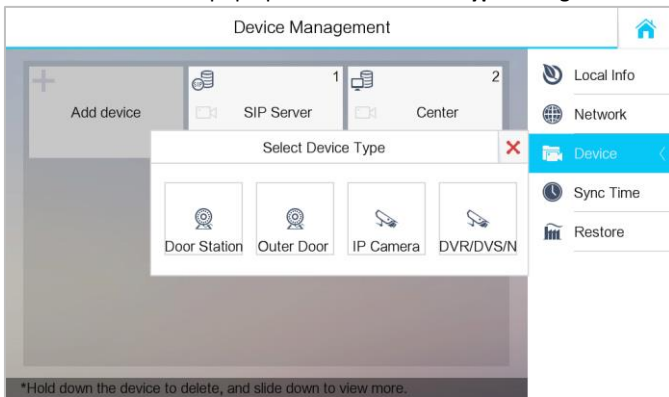



Figure 3-8 Device Type Selecting

2. Select **Door Station** or **Outer Door Station**.
3. Enter the corresponding device information required on the pop-up device adding dialogue box.

Figure 3-9 Door Station Adding

Figure 3-10 Outer Door Station Adding

4. Press the  tab on the upper left corner of the dialogue box.



- When the door station being added, the device name, IP address, project number, community number, building number, and serial number need to be entered.
- When the outer door station being added, the device name, IP address, project number, and serial number need to be entered.
- When the door station and outer door station added successfully, you can get the live view of door station and outer door station in the **Live View** interface.

### Adding the IP Camera

#### Steps:

1. Press the **Add Device** tab to pop up the **Select Device Type** dialogue box.
2. Select **IP Camera**.
3. Enter the corresponding device information required on the pop-up device adding dialogue box.

Figure 3-11 IP camera Adding Interface

4. Press the  tab on the upper left corner of the dialogue box.



- The default Port No. is 554, the default user name is admin.
- The port No. should be consistent with the RTSP (Real Time Streaming Protocol) port No. of the IP camera.
- When the IP camera added successfully, you can get the live view of IP camera on the live view interface.

## Adding DVR/DVS/NVR

### Steps:

1. Press the **Add Device** tab to pop up the **Select Device Type** dialogue box.
2. Select **DVR/DVS/NVR**.
3. Enter the corresponding device information required on the pop-up device adding dialogue box.

Figure 3-12 NVR/DVS/NVR Adding Interface



4. Press the  tab on the upper left corner of the dialogue box.



- The default Port No. is 554, the default channel No. is 1, and the default user name is admin.
- The port No. should be consistent with the RTSP (Real Time Streaming Protocol) port No. of DVR/DVS/NVR.

## 3.4.6 Synchronizing Time

### Steps:

1. Get to the configuration interface: **Settings -> Configuration**, and enter the admin password (configuration password).
2. Press the **Sync Time** tab.
3. Switch  to  to enable NTP.

- Set the synchronizing interval, enter the IP address of NTP server and port No., and select the time zone.



The unit of synchronizing interval is minute, and the default port No. is 123.

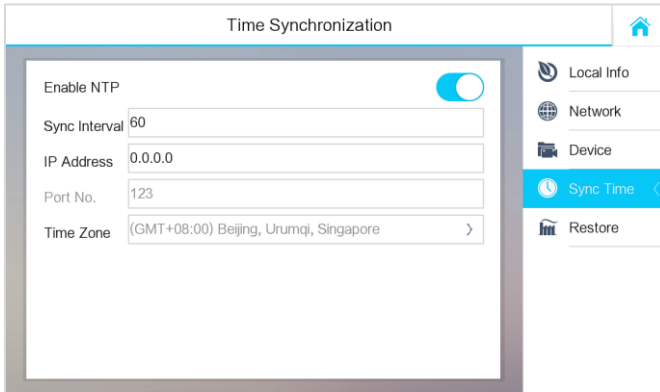

Figure 3-13 Time Synchronizing

### 3.4.7 Restoring Default Settings

**Steps:**

- Get to the configuration interface: **Settings -> Configuration**, and enter the admin password (configuration password).
- Press the **Restore** tab.
- Press the **RESTORE** tab to reboot the system after restoring the default settings.

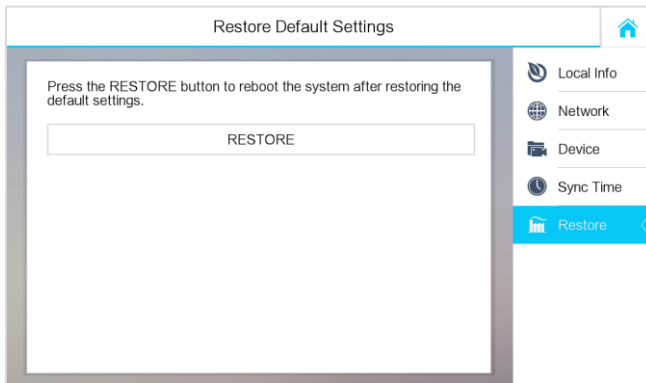





Figure 3-14 Default Settings Restoring



## 3.5 Video Call Settings

### 3.5.1 Calling Resident

**Steps:**

1. Press the  tab on the touch screen to enter the residents calling interface.
2. Enter the corresponding residents' Room No..
3. Press the  tab to start a video intercom call.
4. Press the  tab to stop the video intercom call.



- The room No. format should be like 1-1-1-102 as Community 1, Building 1, Unit 1, and Room 102. The community No. can be omitted.
- Switch  to  on the upper right corner to enable the camera function.

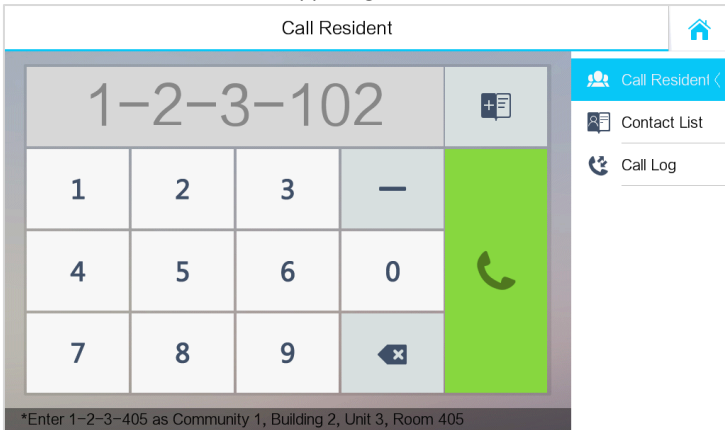



Figure 3-15 Call Resident Interface



### 3.5.2 Calling Master Station

Master Stations can call each other by entering the master station No..



**Steps:**

1. Press the  tab to enter the resident calling interface.
2. Enter the corresponding master stations' No..



3. Press the  tab to start a video intercom call.
4. Press the  Cancel tab to stop the video intercom call.



- The master station No. format should be like 1-51 as Community 1, No. 51. The community No. can be omitted.
- Switch  to  on the upper right corner to enable the camera function.

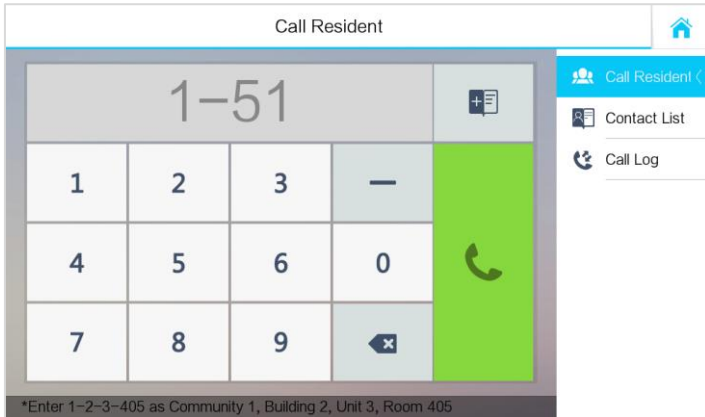



Figure 3-16 Calling Master Station Interface

### 3.5.3 Adding Resident Information

**Steps:**

1. Press the  Contact List tab on the touch screen to enter the contact list interface.
2. Press the **Add Contact** tab.
3. Enter the corresponding residents' information required on the pop-up adding dialogue box.
4. Press the  tab on the upper left corner of the dialogue box.

### 3.5.4 Viewing Call Logs

**Steps:**

1. Press the  button on the touch screen to enter the Call Log interface.
2. Press tab **Missed Call** or **All Calls** to view missed call logs or all call logs.

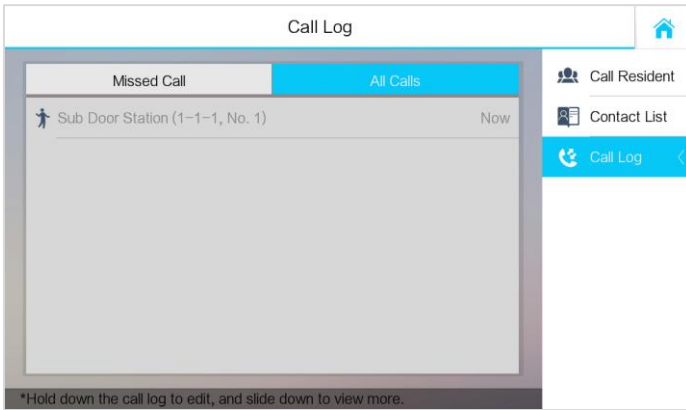
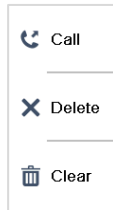

Figure 3-17 Call Log Interface



- Hold down a piece of call log to open the call log handling menu.



- Press the **Call** tab to call back.
- Press the **Delete** tab to delete the piece of call log.
- Press the **Clear** tab to delete all pieces of call logs.
- When there is any missed call, the number of missed call will display on the tab



as a prompt, e.g. the icon



means there is 1 missed call.

### 3.6 Viewing Alarm Messages

After connecting indoor/door stations to the master station via the SIP server, the master station can automatically receive alarm messages of indoor/door stations, such as alarm message for not-closed door, tamper alarm, and so on.

Press the **New Message** tab on the user interface to view alarm messages of indoor/door stations.

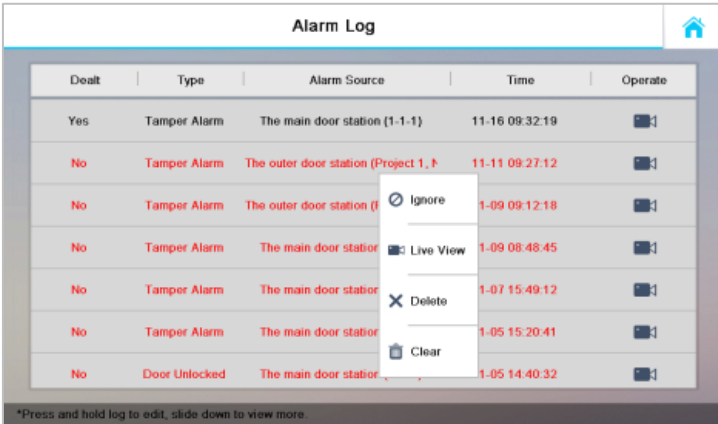
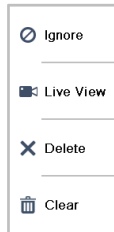

Figure 3-18 Alarm Log Interface



- Hold down a piece of alarm message to open the alarm message handling menu.



- Press the **Ignore** tab to ignore the piece of alarm message.
- Press the **Live View** tab to enter the live view interface.
- Press the **Delete** tab to delete the piece of alarm message.
- Press the **Clear** tab to delete all pieces of alarm messages.

- When there is any alarm message, the tab



turns to

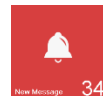

as a prompt

### 3.7 Live View

**Steps:**



1. Press the **Live View** tab on the touch screen to enter the Live View interface.

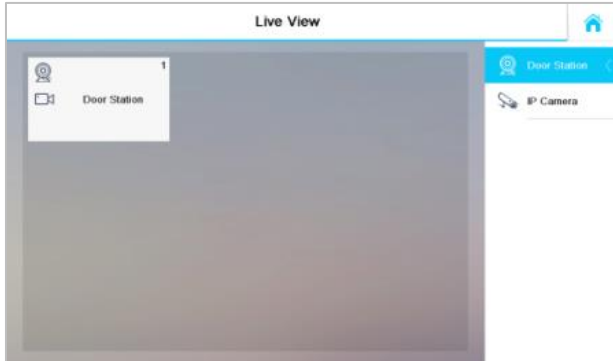

Figure 3-19 Live View Interface

2. Press the **Door Station** tab and press the door station device to view the live view of the corresponding door station.



Figure 3-20 Live View of Door Station

3. Press the **IP Camera** tab and press the IPC device to view the live view of the corresponding IPC.



Figure 3-21 Live View of IPC

## 4 Remote Configuration via Batch Configuration Tool

You can configure and operate the video intercom devices via Batch Configuration Tool. Default parameters of master station are as follows:

- Default IP Address: 192.0.0.64.
- Default Port No.: 8000.
- Default User Name: admin.

### 4.1 Activating Device Remotely

#### Purpose

You are required to activate the device first by setting a strong password for it before you can use the device.

Activation via Batch Configuration Tool, and Activation via iVMS-4200 are supported. Here take activation via Batch Configuration Tool as example to introduce the device activation. Please refer to the user manual for the activation via iVMS-4200.

#### Steps:

1. Run the Batch Configuration Tool.

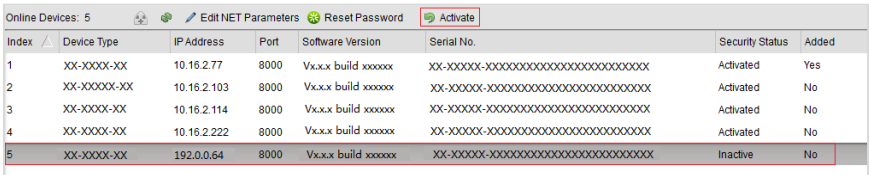

Index	Device Type	IP Address	Port	Software Version	Serial No.	Security Status	Added
1	XX-XXXX-XX	10.16.2.77	8000	Vx.x.x build xxxxxx	XX-XXXXX-XXXXXXXXXXXXXXXXXXXXXXXXXXXX	Activated	Yes
2	XX-XXXXX-XX	10.16.2.103	8000	Vx.x.x build xxxxxx	XX-XXXXX-XXXXXXXXXXXXXXXXXXXXXXXXXXXX	Activated	No
3	XX-XXXX-XX	10.16.2.114	8000	Vx.x.x build xxxxxx	XX-XXXXX-XXXXXXXXXXXXXXXXXXXXXXXXXXXX	Activated	No
4	XX-XXXX-XX	10.16.2.222	8000	Vx.x.x build xxxxxx	XX-XXXXX-XXXXXXXXXXXXXXXXXXXXXXXXXXXX	Activated	No
5	XX-XXXX-XX	192.0.0.64	8000	Vx.x.x build xxxxxx	XX-XXXXX-XXXXXXXXXXXXXXXXXXXXXXXXXXXX	Inactive	No

Figure 4-1 Selecting Inactive Device

2. Select an inactivated device and click the **Activate** button.

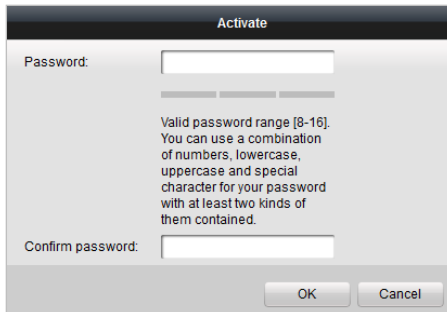

**Activate**

Password:

Valid password range [8-16].  
You can use a combination  
of numbers, lowercase,  
uppercase and special  
character for your password  
with at least two kinds of  
them contained.

Confirm password:

OK Cancel

Figure 4-2 Activation

3. Create a password, and confirm the password.



**STRONG PASSWORD RECOMMENDED**– *We highly recommend you create a strong password of your own choosing (Using a minimum of 8 characters, including at least three of the following categories: upper case letters, lower case letters, numbers, and special characters.) in order to increase the security of your product. And we recommend you reset your password regularly, especially in the high security system, resetting the password monthly or weekly can better protect your product.*

4. Click the **OK** button to activate the device.



- When the device is not activated, the basic operation and remote operation of device cannot be performed.
- You can hold the **Ctrl** or **Shift** key to select multiple devices in the online devices, and click the **Activate** button to activate devices in batch.

## 4.2 Editing Network Parameters

### Purpose:

To operate and configure the device via LAN (Local Area Network), you need connect the device in the same subnet with your PC. You can edit network parameters via batch configuration tool, and iVMS-4200 software. Here take editing network parameters via batch configuration tool as example.

### Steps:

1. Select an online activated device and click the **Edit NET Parameters** button.

Online Devices: 5								
<span>Edit NET Parameters</span> <span>Reset Password</span> <span>Activate</span>								
Index	Device Type	IP Address	Port	Software Version	Serial No.	Security Status	Added	
1	XX-XXXX-XX	10.16.2.77	8000	Vx.x.x build xxxxxx	XX-XXXX-XXXXXXXXXXXXXXXXXXXXXX	Activated	Yes	
2	XX-XXXX-XX	10.16.2.114	8000	Vx.x.x build xxxxxx	XX-XXXX-XXXXXXXXXXXXXXXXXXXXXX	Activated	No	
3	XX-XXXX-XX	10.16.2.103	8000	Vx.x.x build xxxxxx	XX-XXXX-XXXXXXXXXXXXXXXXXXXXXX	Activated	No	
4	XX-XXXX-XX	192.0.0.64	8000	Vx.x.x build xxxxxx	XX-XXXX-XXXXXXXXXXXXXXXXXXXXXX	Activated	No	
5	XX-XXXX-XX	10.16.2.222	8000	Vx.x.x build xxxxxx	XX-XXXX-XXXXXXXXXXXXXXXXXXXXXX	Activated	No	

Figure 4-3 Clicking Edit NET Parameters Button

2. Change the device IP address and gateway address to the same subnet with your computer.
3. Enter the password and click the OK button to activate the network parameters modification.

Figure 4-4 Editing Network Parameters



- The default port No. is 8000.
- The default IP address of the master station is 192.0.0.64.
- After editing the network parameters of device, you should add the devices to the device list again.
- Enable DHCP, and the software can obtain network parameters for the device automatically.

## 4.3 Adding Device

### ***Before you start:***

Make sure the device to be added has been activated.

### ***Purpose:***

For batch configuration tool software, you should add device to the software so as to configure the device remotely.

The software provides 3 ways for adding the devices. You can add the active online devices within your subnet, add devices by IP address, and add devices by IP segment.

### 4.3.1 Adding Online Device

#### ***Before you start:***

Make sure the device to be added is in the same subnet with your computer. Otherwise, please edit network parameters first.

#### ***Steps:***

1. Select an active online device or hold the **Ctrl** or **Shift** key to select multiple devices in the online devices list.



Index	Device Type	IP Address	Port	Software Version	Serial No.	Security Status	Added
1	XX-XXXX-XX	10.16.2.77	8000	Vx.x.x build xxxxxx	XX-XXXX-XXXXXXXXXXXXXXXXXXXX	Activated	Yes
2	XX-XXXX-XX	10.16.2.114	8000	Vx.x.x build xxxxxx	XX-XXXX-XXXXXXXXXXXXXXXXXXXX	Activated	No
3	XX-XXXX-XX	10.16.2.103	8000	Vx.x.x build xxxxxx	XX-XXXX-XXXXXXXXXXXXXXXXXXXX	Activated	No
4	XX-XXXX-XX	10.16.2.88	8000	Vx.x.x build xxxxxx	XX-XXXX-XXXXXXXXXXXXXXXXXXXX	Activated	No
5	XX-XXXX-XX	10.16.2.222	8000	Vx.x.x build xxxxxx	XX-XXXX-XXXXXXXXXXXXXXXXXXXX	Activated	No

Figure 4-5 Online Devices Interface

- Click the button to pop up the login dialog box.

**Login**

**Log into the selected device(s):**

User Name:

Password:

Figure 4-6 Login Dialog Box

- Enter the user name and password.
- Click the **OK** button to save the settings.



- Only devices successfully logged in will be added to the device list for configuration.
- If you add devices in batch, please make sure selected devices have the same user name and password.

### 4.3.2 Adding by IP Address

**Purpose:**

You can add the device by entering IP address.

**Steps:**

- Click the button to pop up the adding devices dialog box.

Device(s) in the list will be configured.

Device List: 1 Remote Configurator Flash rom Batch Update Linked Network Batch Configuration Filter: Device List

Index	Device Type	IP Address	Port	Software Version	Serial No.	Security Status	Configuration Status	Configuration
<input type="checkbox"/> 1	XX-XXXX-XX	10.16.2.8	8000	V x.x.x build xxxxxx	XX-XXXXXXXXXXXXXXXXXXXX	Strong password		

Figure 4-7 Adding Button

- Select IP Address in the adding mode drop-down list.
- Enter the IP address, and set the port No., user name and password of the device.

Figure 4-8 Adding by IP Address

4. Click the **OK** button to add the device to the device list.



- You cannot add the device(s) to the device list if the user name and password are not identical.
- When you add devices by IP Address, or IP Segment, the devices should be online devices.

### 4.3.3 Adding by IP Segment

**Purpose:**

You can add many devices at once whose IP addresses are among the IP segment.

**Steps:**

1. Click the button to pop up the adding devices dialog box.

Index	Device Type	IP Address	Port	Software Version	Serial No.	Security Status	Configuration Status	Configuration
1	XX-XXXX-XX	10.16.2.8	8000	V x.x.x build xxxxxx	XX-XXXXXXXXXXXXXXXXXXXX	Strong password		

Figure 4-9 Adding Button

2. Select IP Segment in the adding mode drop-down list.
3. Set the Start IP Address and End IP Address.
4. Enter port No., user name, and password.

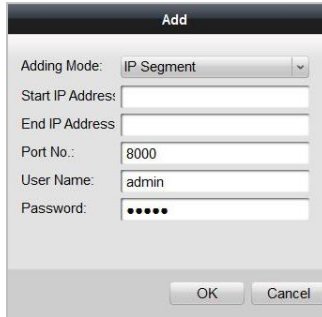



Figure 4-10 Adding by IP Segment

5. Click the **OK** button to search and add the devices whose IP addresses are within the range of the defined IP segment to the device list.

## 4.4 Configuring Devices Remotely

In the device list area, select a device and click  **Remote Configuration** or  to enter the remote configuration interface.

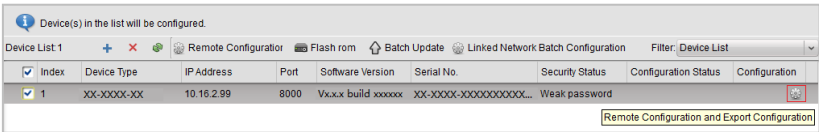

Figure 4-11 Remote Configuration

### 4.4.1 System

Click the **System** button on the remote configuration interface to display the device information: Device Information, General, Time, System Maintenance, User, and RS485.

#### Device Information

Click the **Device Information** button to enter device basic information interface. You can view basic information (the device type, and serial No.), and version information of the device.



Figure 4-12 Device Information

## General

Click the **General** button to enter device general parameters settings interface. You can view and edit the device name and device ID.

Figure 4-13 General

## Time

### Steps:

1. Click the **Time** button to enter the device time settings interface.

Figure 4-14 Time Settings

2. Select Time Zone or Enable NTP.

- **Time Zone**

- 1) Select a time zone from the drop-down list menu.
- 2) Click the **Synchronization** button.

- **NTP**

- 1) Check the checkbox of Enable NTP to enable NTP.
- 2) Enter the server address, NTP port, and synchronization interval.

- **DST**

- 1) Check the checkbox of Enable DST to enable DST.
- 2) Enter the start time and end time of DST, and set the DST bias.

3. Click the **Save** button to save and realize the time settings.



The default port No. is 123.

## System Maintenance

### **Purpose:**

You can operate the system management and remote upgrading on the system maintenance interface.

### **Steps:**

1. Click the **System Maintenance** button to enter the system maintenance interface.

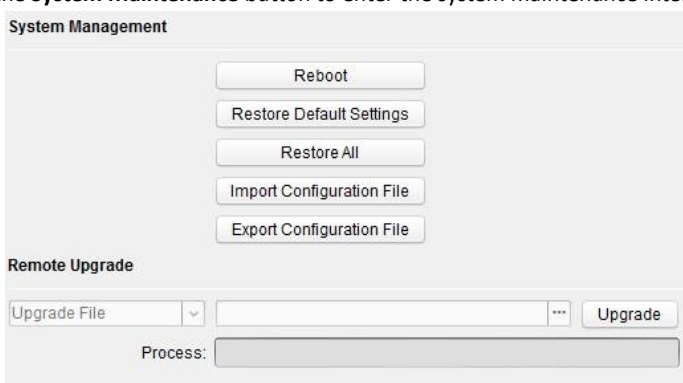

Figure 4-15 System Maintenance

2. Click **Reboot** and the system reboot dialog box pops up. Click **Yes** to reboot the system.
3. Click **Restore Default Settings** to restore the default parameters.
4. Click **Restore All** to restore all parameters of device and reset the device to inactive status.
5. Click **Import Configuration File** and the import file window pops up. Select the path of remote configuration files. Click **Open** to import the remote configuration file. The configuration file is imported and the device will reboot automatically.

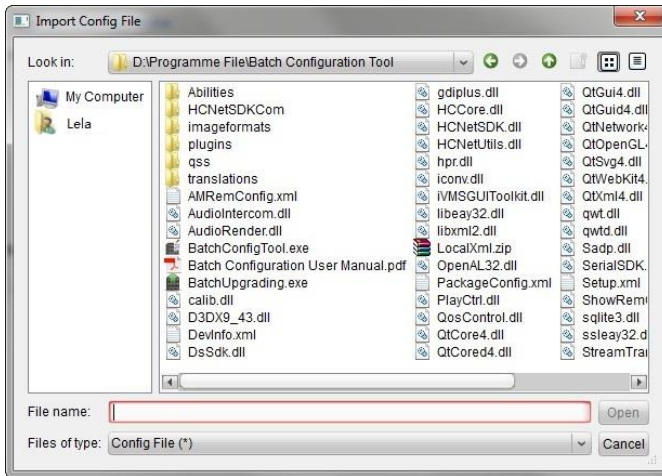

Figure 4-16 Import File

6. Click **Export Configuration File** and the export file window pops up. Select the saving path of remote configuration files and click **Save** to export the configuration file.

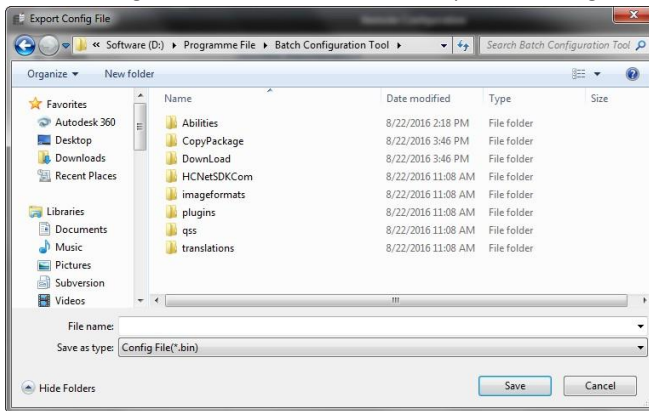



Figure 4-17 Export File

7. Click  to select the upgrade file and click **Upgrade** to remote upgrade the device. The process of remote upgrade will be displayed in the process bar.

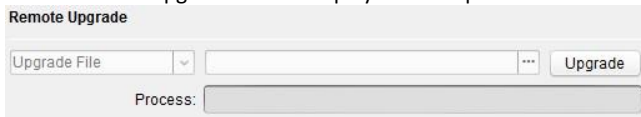

Figure 4-18 Remote Upgrade



- Click **Restore Default Settings** button, all default settings, excluding network parameters, will be restored.
- Click **Restore All** button, all default settings, including network parameters, will be restored. The device will be reset to inactivated status.

## User

### Purpose:

You can edit the password for logging in the device.

### Steps:

1. Click the **User** button to enter the user information editing interface.

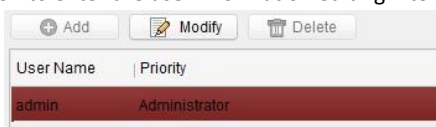

Figure 4-19 Select User Name

2. Select the user to edit and click the **Modify** button to enter the user parameter interface.

Figure 4-20 Modify User Information

3. Enter the new password, and confirm it.
4. Click the **Save** button to realize the editing of password.



- The new password and confirm password should be identical.

- After editing the password of device, click  button from the device list, the added device will not be there. You should add the device again with new password to operate the remote configuration.

## RS485

Click the **RS485** button to enter the RS485 setting interface. You can view and edit the RS485 parameters of the device.

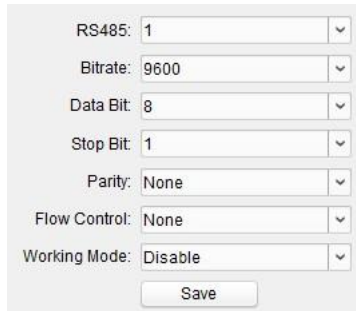

RS485: 1

Bitrate: 9600

Data Bit: 8

Stop Bit: 1

Parity: None

Flow Control: None

Working Mode: Disable

Save

Figure 4-21 RS-485



For indoor station and master station, there are 3 choices for the working mode: transparent channel, disable, and custom.

### 4.4.2 Video Intercom

Click the **Video Intercom** button on the remote configuration interface to enter the video intercom parameters settings: Device Number Configuration, Time Parameters, Password, IP Camera Information, and Volume Input and Output Configuration.

#### Device ID Configuration

##### Steps:

1. Click the **ID Configuration** button to enter device ID configuration interface.



Device No. Configuration

Device Type: Master Station

Community No.: 1

No.: 51

Save

Figure 4-22 Device No. Configuration

2. Set the corresponding information.
3. Click the **Save** button to enable the device number configuration.



## Time Parameters

1. Click the **Time Parameters** button to enter time parameters settings interface.
2. Configure the maximum ring duration, maximum live view time, and maximum speaking time.
3. Click the **Apply** button.

The screenshot shows a web interface titled "Time Parameters". At the top, there is a dropdown menu labeled "Device Type" with "Master Station" selected. Below this are three rows of input fields: "Max. Ring Duration" with the value "30" and a unit "s", "Max. Live View Duration" with the value "30" and a unit "s", and "Max. Speaking Duration" with the value "90" and a unit "s". At the bottom of the form is a "Save" button.

Figure 4-23 Time Parameters



- Maximum ring duration is the maximum duration of master station when it is called without being received. The range of maximum ring duration varies from 30s to 60s.
- Maximum live view time is the maximum time of playing live view of the master station. The range of maximum live view time varies from 10s to 60s.
- Maximum speaking duration is the maximum time of master station when it communicates with other video intercom devices. The range of maximum speaking duration varies from 90s to 120s.

## Password

Click the **Password** button to enter password changing interface.

You can change the admin password of the master password on this interface.

The screenshot shows a web interface titled "Permission Password". At the top, there is a dropdown menu labeled "Password Type" with "Admin Password" selected. Below this are three rows of input fields: "Old Password", "New Password", and "Confirm Password". At the bottom of the form is a "Save" button.

Figure 4-24 Password Configuration

## Volume Input and Output

Click **Volume Input and Output** to enter the volume input and output interface. Slide the slider to adjust the volume input and volume output.

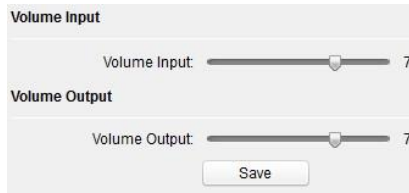

Figure 4-25 Volume Configuration

## IP Camera Information

### Purpose:

You can add, delete and modify devices that can be added to the master station, such as IP cameras, door stations, outer door stations, and DVR/NVR/DVS. By exporting and importing the added device information, you can edit added devices parameters in batch.

### Adding IP Camera, DVR/NVR/DVS, Door Station and Outer door Station

#### Steps:

1. Click the **IP Camera Information** button to enter IP camera information interface.

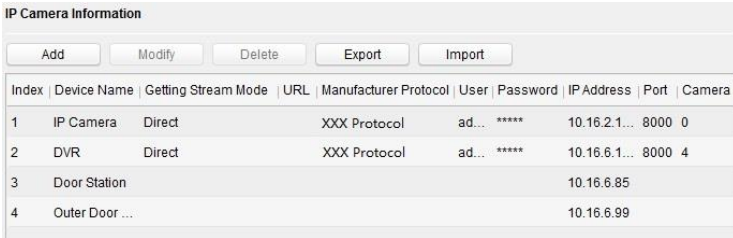

Figure 4-26 IP Camera Information

2. Click the **Add** button to pop up the device adding dialogue box.
3. Select the device type from the drop-down list menu: IP Camera, door station, outer door station, and DVR/NVR/DVS.
4. Enter corresponding information, and click the **OK** button.

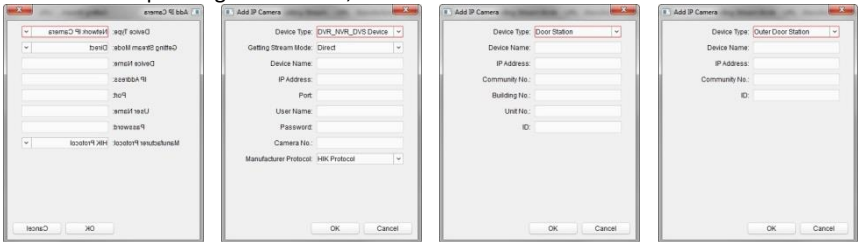

Figure 4-27 Adding Devices

## Exporting and Importing Added Device Information

### Steps:

1. Click the **Export** button to export the added device information file.

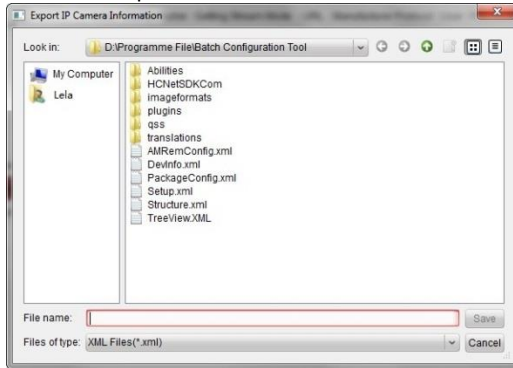

Figure 4-28 Export Information

2. Edit parameters of added devices in batch in the exported file.
3. Click the **Import** button to pop up importing box, and open the edited added device information file.

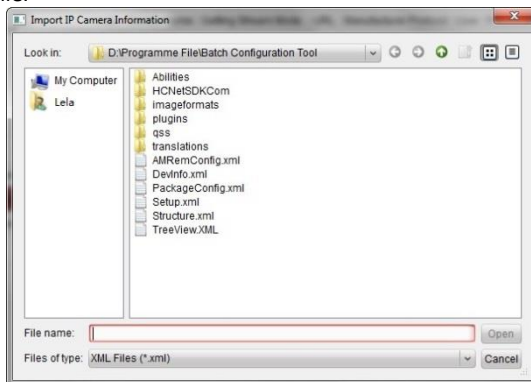

Figure 4-29 Import Information

## 4.4.3 Network

### Local Network Configuration

#### Steps:

1. Click the **Local Network Configuration** button to enter local network configuration interface.

Local Network Configuration

Local IP Address: 10.16.6.159

IP Address Subnet Mask: 255.255.255.0

Default Gateway: 10.16.6.254

Port: 8000

HTTP Port: 80

Save

Figure 4-30 Local Network Parameters

2. Enter the local IP address, subnet mask, gateway address, and port No..
3. Click the **Save** button to enable the settings.



- The default port No. is 8000.
- After editing the local network parameters of device, you should add the devices to the device list again.

## Linked Devices Network Configuration

### **Purpose:**

In the linked devices network configuration interface, you can configure the network parameters of master stations, SIP servers and management centers of the same LAN. The devices can be linked to the door station and realize the linkage between these devices.

### **Steps:**

1. Click the **Linked Network Configuration** button to enter linked network configuration interface.

Linked Network Configuration

Device Type: Master Station

SIP Server IP Address: 0.0.0.0

Security Control Panel IP Address: 0.0.0.0

Security Control Panel Port No.: 0

Save

Figure 4-31 Linked Network Configuration

2. Enter the SIP server IP address, security control panel IP address and security control panel port No..
3. Click the **Save** button to enable the settings.

## 4.5 Batch Upgrading

In the device list area, click **Batch Update** to enter the batch upgrading interface.

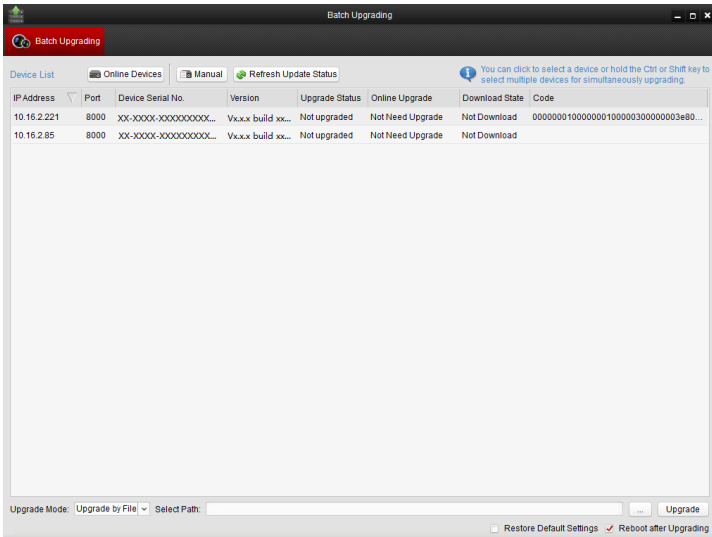

Figure 4-32 Batch Upgrading

### 4.5.1 Adding Devices for Upgrading

You should add the device to the batch upgrading tool first before upgrading the device. There are 2 ways to add the device: adding online device, and adding by IP address/IP segment.

#### Adding Online Device

**Steps:**

1. In the batch upgrading interface, click the **Online Devices** button to open the online device window.

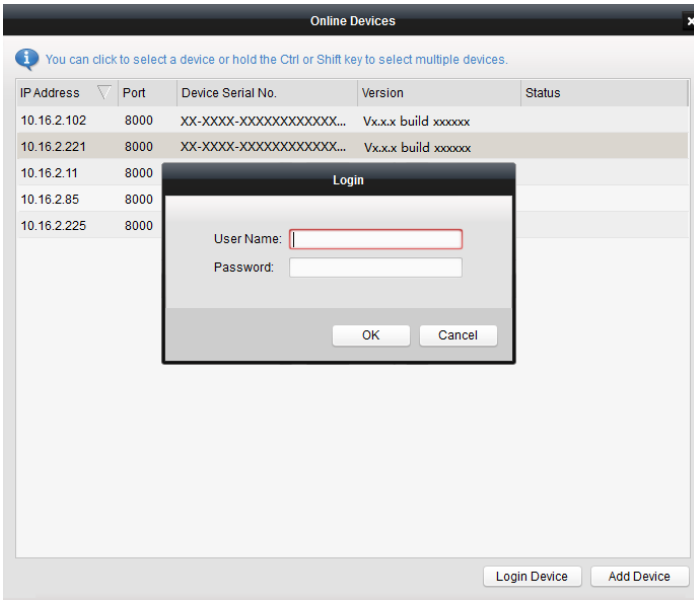

Figure 4-33 Login

2. Select a device, enter the user name and password, and click the **Login Device** button.
3. Click the **Add Device** button, and the device is added to the batch upgrading tool.

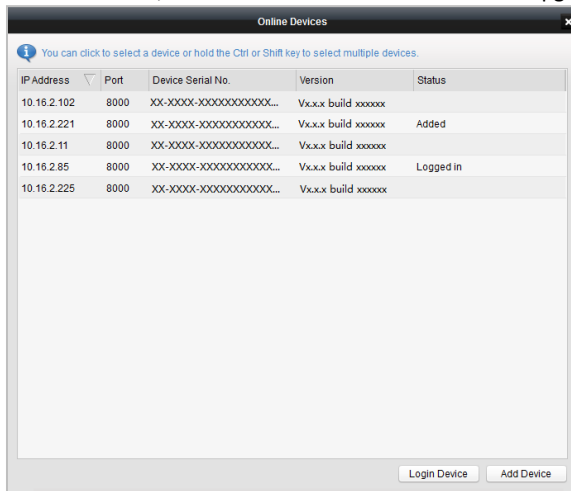

Figure 4-34 Online Devices

## Adding by IP Address/IP Segment

### Steps:

1. Click the **Manual** button to open the device adding window.
2. Enter the corresponding information (IP address, user name, password, start IP address, end IP address).
3. Click the **Add** button.

The screenshot shows a 'Search' dialog box with two sections: 'By IP' and 'By IP Segmen'. The 'By IP' section has fields for 'IP Address', 'Port' (8000), 'User Name', and 'Password', with an 'Add>>' button. The 'By IP Segmen' section has fields for 'Start IP', 'End IP', 'Port' (8000), 'User Name', and 'Password', with an 'Add>>' button. A 'Cancel' button is at the bottom right.

Figure 4-35 Adding by IP Address/IP Segment

## 4.5.2 Upgrading Devices

There are 2 upgrading modes available: upgrading by file, and online upgrading.

### Upgrading by File

Upgrading by File: You upgrade the device or devices via the local upgrade files.

### Steps:

1. Select a device or multiple devices, and select "Upgrade by File" as the upgrading mode.
2. Click  to pop up the window for opening the upgrading file.

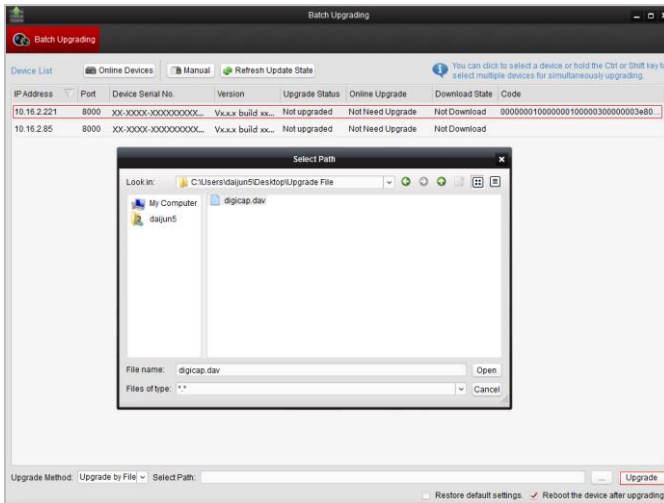

Figure 4-36 Upgrade by File

3. Open the upgrading file, and click the **Upgrade** button.

### Online Upgrading

Online Upgrading: The batch upgrading tool will search the latest upgrading file for the device automatically. You upgrade the device or devices via the local upgrading files.

#### Steps:

1. Select a device or multiple devices, and select “Online Upgrading” as the upgrading mode.
2. Click the **Download** button. Click the **Upgrade** button after the online upgrading file has been wholly downloaded.



## 5 Remote Operation via iVMS-4200

### 5.1 System Configuration

#### **Purpose:**



You can configure the video intercom parameters accordingly.

#### **Steps:**

1. Open the System Configuration page.

Path: **Control Panel -> Maintenance and Management -> System Configuration -> Video Intercom.**

2. Click the **Video Intercom** tab to enter the Video Intercom Settings interface.
3. Input the required information.

**Ringtone:** Click the icon  and select the audio file from the local path for the ringtone of indoor station. Optionally, you can click the icon  for a testing of the audio file.

**Max. Ring Duration:** Input the maximum duration of the ringtone, ranging from 15 seconds to 60 seconds.

**Max. Speaking Duration with Indoor Station:** Input the maximum duration of speaking with the indoor station, ranging from 120 seconds to 600 seconds.

**Max. Speaking Duration with Door Station:** Input the maximum duration of speaking with the door station, ranging from 90 seconds to 120 seconds.

**Card Reader Type:** Select the card reader to issue cards.

4. Click **Save** to save the settings.

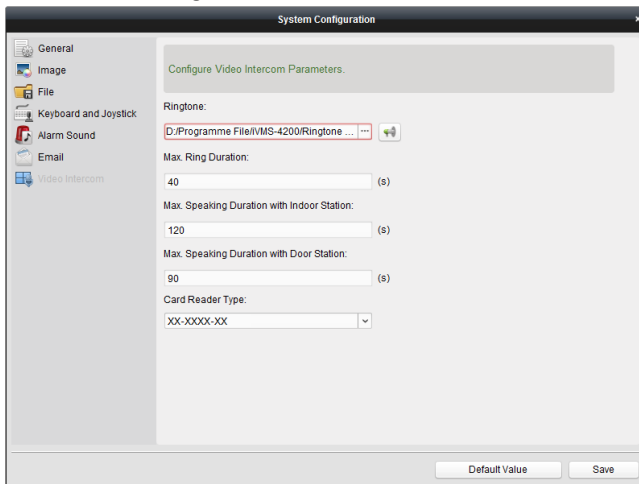

Figure 5-1 System Configuration Interface

## 5.2 Device Management

### Purpose:

Device management includes device activation, adding device, editing device, and deleting device, and so on.

After running the iVMS-4200, video intercom devices should be added to the client software for remote configuration and management.

### 5.2.1 Adding Video Intercom Devices



- You can add at most 512 indoor stations and master stations in total to the iVMS-4200, and add at most 16 door stations to the iVMS-4200.
- For video intercom devices, you are required to create the password to activate them before they can be added to the software and work properly. For device activation via creating password, please refer *User Manual of iVMS-4200 (Video Intercom) V2.4.2* in the disk for detail steps.
- You can add online video intercom devices, and add them manually. Here take adding online video intercom devices as example. For adding video intercom devices manually, please refer *User Manual of iVMS-4200 (Video Intercom) V2.4.2* in the disk for detail steps.

### Steps:



1. Click the  icon on the control panel, or click **Tools->Device Management** to open the Device Management page.
2. Click the **Server** tab.

#### To add indoor station or master station:

- 1) Click **Add New Device Type** to enter add new device type interface. Select **Indoor Station/Master Station** and click **OK**.

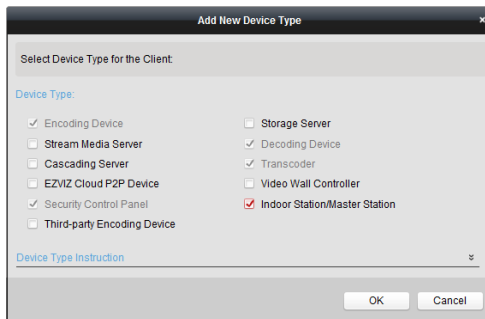

Figure 5-2 Adding New Device Type

- 2) In the Server tab, Video Intercom Device will display, select **Video Intercom Device** and add indoor station and master station.

**To add door station:**

In the Server tab, select **Encoding Device/Outdoor Device** and add door station.

3. The active online devices in the same local subnet with the client software will be displayed on the **Online Device** area. You can click the **Refresh Every 60s** button to refresh the information of the online devices.

IP	Device Type	Firmware Version	Security	Server Port	Start Time	Added
10.16.2.11	XX-XXXX-XX	Vx.x.x build xxxxxx	Active	8000	2016-07-05 09:21:55	No
10.16.2.85	XX-XXXX-XX	Vx.x.x build xxxxxx	Active	8000	2019-01-21 21:43:24	Yes
10.16.2.102	XX-XXXX-XX	Vx.x.x build xxxxxx	Active	8000	2016-07-05 09:33:52	No

Figure 5-3 Online Devices



To add online devices to the software, you are required to change the device IP address to the same subnet with your computer first.

4. Select the devices to be added from the list.
5. Click **Add to Client** to open the device adding dialog box.
6. Input the required information.

**Nickname:** Edit a name for the device as you want.

**Address:** Input the device’s IP address. The IP address of the device is obtained automatically in this adding mode.

**Port:** Input the device’s port No.. The default value is 8000.

**User Name:** Input the device’s user name. By default, the user name is admin.

**Password:** Input the device’s password. By default, the password is **12345**.

7. Optionally, you can check the checkbox **Export to Group** to create a group by the device name. All the channels of the device will be imported to the corresponding group by default.



iVMS-4200 also provides a method to add the offline devices. Check the checkbox **Add Offline Device**, input the required information and the device channel number and alarm input number, and then click **Add**. When the offline device comes online, the software will connect it automatically.

8. Click **Add** to add the device.

Add

Adding Mode:

IP/Domain  
  IP Segment  
  IP Server  
  HIDDNS  
  Batch Import

Add Offline Device

Nickname:

Address:

Port:

User Name:

Password:

Export to Group

Set the device name as the group name and add all the channels connected to the device to the group.

Figure 5-4 Adding Device by IP/Domain



### Add Multiple Online Devices

If you want to add multiple online devices to the client software, click and hold Ctrl key to select multiple devices, and click **Add to Client** to open the device adding dialog box. In the pop-up message box, enter the user name and password for the devices to be added.

### Add All the Online Devices

If you want to add all the online devices to the client software, click Add All and click **OK** in the pop-up message box. Then enter the user name and password for the devices to be added.

## 5.2.2 Modifying Network Information

Select the device from the online list, click **Modify Netinfo**, and then you can modify the network information of the selected device.

Figure 5-5 Modifying Network Information



You should enter the admin password of the device in the **Password** field of the pop-up window to modify the parameters.

### 5.2.3 Resetting Password

According to the different video intercom devices, the software provides two different methods for restoring the default password or resetting the password.

Select the device from the online device list, click **Reset Password**.

**Option 1:**

If the window with import file button, key importing mode drop-down list, password and confirm password field pops up, follow the steps below to reset the password:



This option is available to door stations.

Figure 5-6 Resetting Password (Option 1)

1. Click **Export** to save the device file on your computer.
2. Send the file to our technical engineers.
3. Our technical engineer will send a file to you. After receiving a file from the technical engineer, select **Import File** from Key Importing Mode drop-down list and click  to import the file.
4. Input new password in text fields of **Password** and **Confirm Password**.
5. Click **OK** to reset the password.

**STRONG PASSWORD RECOMMENDED**— *We highly recommend you create a strong password of your own choosing (Using a minimum of 8 characters, including at least three of the following categories: upper case letters, lower case letters, numbers, and special characters.) in order to increase the security of your product. And we recommend you reset your password regularly, especially in the high security system, resetting the password monthly or weekly can better protect your product.*

**Option 2:**

If the window with import file and export file buttons, password and confirm password field pops up, follow the steps below to reset the password:

**Note:** This option is available to indoor stations and master stations.

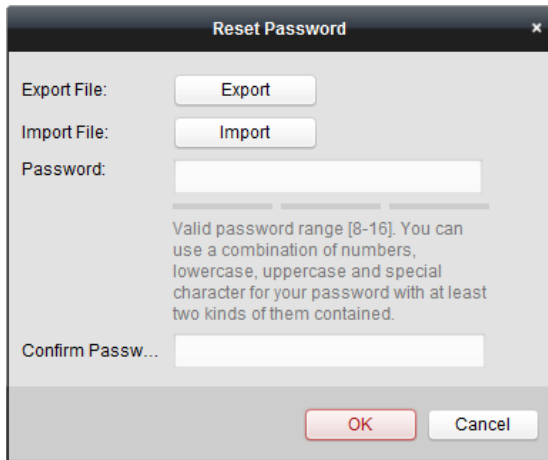

Figure 5-7 Resetting Password (Option 2)

1. Click **Export** to save the device file on your computer.
2. Send the file to our technical engineers.
3. Click **Import** and select the file received from the technical engineer.
4. Input new password in text fields of **Password** and **Confirm Password**.
5. Click **OK** to reset the password.

**STRONG PASSWORD RECOMMENDED**

*We highly recommend you create a strong password of your own choosing (Using a minimum of 8 characters, including at least three of the following categories: upper case letters, lower case letters, numbers, and special characters.) in order to increase the security of your product. And we recommend you reset your password regularly, especially in the high security system, resetting the password monthly or weekly can better protect your product.*

## 5.3 Configuring Devices Remotely via iVMS-4200

Configuring devices remotely via iVMS-4200 is the same with that via Batch Configuration Tool, please refer 4.4 *Configuring Devices Remotely* for detail steps.

## 5.4 Device Arming Control

### Steps:

1. Select **Tool->Device Arming Control** to enter the device arming control interface.



Figure 5-8 Tool Menu

- Set the arming status of the device as armed, and the alarm information will be auto uploaded to the client software when alarm occurs.



Figure 5-9 Device Arming Control

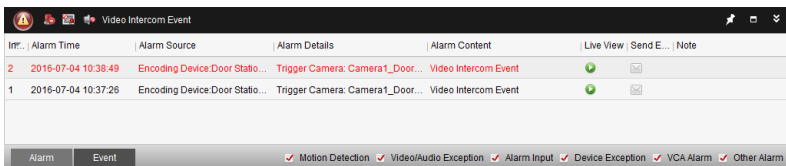

Figure 5-10 Alarm Events



After adding the device to the client software, it will be armed automatically.



# Appendix

---

## Wiring Cables

Cables	Specification
Power Cable	RVV 2*1.0
Network Cable	Cat5e



### Warning

To avoid echo and whistles, set the wire distance longer than 8 meters.

---



First Choice for Security Professionals